

# X20

# Portable Power Bank

## User Manual v3.0

Please Read This Manual Before Use And Follow Its Guidance.  
Keep This Manual For Future Reference.





## Thank You

Thank you for making BLUETTI a part of your family.

From the very beginning, BLUETTI has tried to stay true to a sustainable future through green energy storage solutions while delivering an exceptional eco-friendly experience for our homes and our world.

That's why BLUETTI makes its presence in 100+ countries and is trusted by millions of customers across the globe.



**Shenzhen PowerOak Newener Co., Ltd.**

F19, BLD No.1, Kaidaer, Tongsha RD No.168, Xili street, Nanshan, Shenzhen, China

Web: <https://www.bluettipower.com>

Copyright © Shenzhen PowerOak Newener Co., Ltd. All rights reserved.

No part of this document may be reproduced or transmitted in any form or by any means without the prior written consent of Shenzhen PowerOak Newener Co., Ltd.

## Notice

BLUETTI's products, services, and features are subject to the agreed-upon terms and conditions during purchase. Please note that some products, services, or features described in this manual may not be available under your purchase contract. Unless otherwise specified in the contract, BLUETTI makes no representations or warranties of any kind, express or implied, with respect to the contents of this manual.

The contents of this manual are subject to change without notice. Please get the latest version from: <https://www.bluettipower.com/pages/user-guides>

If you have any questions or concerns about this manual, please contact BLUETTI support for further assistance.

## About the Manual

### Introduction



This manual provides information on the functionality, basic operation and safety instructions of the X20 Power Bank (hereinafter referred to as X20). Please read and understand all instructions in this manual before use.

### Target Audience

- Technical support engineer
- End-user

### Symbol Conventions

This manual uses the following symbols to highlight important information:

Symbol	Category	Description
	Danger / Warning / Attention	It indicates a hazardous situation which, if not avoided, could result in death or serious injury.
	Notice	It indicates a potentially hazardous situation which, if not avoided, could cause substantial damage to property and the environment.

# Contents

1	Safety Instructions .....	06
2	Packing List .....	08
3	Product Overview .....	10
4	LCD Display .....	11
5	Operations .....	12
5.1	Power ON / OFF .....	12
5.2	Charging .....	12
5.3	Discharging .....	13
5.4	Shallow Charge Mode .....	13
6	Specifications .....	13
7	Troubleshooting .....	14
	Appx. 1 Abbreviations .....	14

# 1. Safety Instructions

Read this manual for instructions on the proper use and safety information for the product. The safety instructions provided herein are for illustrative purposes that include but are not limited to those listed in this manual. Actual operation shall comply with all applicable safety standards. If you have any questions, feel free to contact BLUETTI support or your local BLUETTI dealers.

## Statement

To ensure a safe operation, it's crucial to observe and adhere to the following conditions:

- Always operate or store the product in the conditions specified in this manual.
- The installation and ambient conditions must comply with the requirements in the relevant international, national, or regional standards.
- Avoid unauthorized disassembly, component replacement, or modification of software codes.

*BLUETTI shall not be liable for the following circumstances:*

- Damage resulting from force majeure events such as earthquakes, fires, storms, floods, or mudslides.
- Damage caused by the customer's own transportation.
- Damage resulting from inadequate storage conditions as specified in the manual.
- Hardware or data damage caused by customer negligence, improper operation, or intentional actions.
- System damage caused by third parties or customers, including but not limited to improper handling and installation not in accordance with the instructions in this manual.
- Damage caused by adjustments, changes, or removal of labels in violation of this manual.

 **WARNING** - Follow these guidelines for proper operation.

- Do not install, use and maintain the product in adverse weather conditions such as lightning, rain, snow and strong breezes (including but not limited to handling and operating the product, plugging and unplugging signal connections to outdoor facilities, working at height, outdoor installations, etc.).
- Always turn off the power source before starting any electrical work.
- Do not clean the product with water.
- Do not disassemble the product on your own.
- Regularly inspect the product and its accessories for damage or deterioration.
- If the product's shell is cracked, do not use it and contact BLUETTI support or your local BLUETTI dealers.

- In case of fire, use only a dry powder fire extinguisher appropriate for the product.
- In case of fire, EVACUATE the building or affected area immediately. Activate the closest FIRE ALARM system and CALL your local emergency phone number.
- Use genuine cables and accessories provided by BLUETTI to reduce the risk of fire, electric shock, or injury to persons.
- Keep the product away from heat resources or high temperatures, and do not expose it to direct sunlight.
- Do not store the product with flammable liquids, gases, or explosive materials.
- Make sure the area where you are using the product is well ventilated and spacious.
- Do not block or cover the vents of the product as this may cause irreversible damage to it.
- Use the product for its intended purpose and avoid stacking objects on top of it during storage or use.
- In case of malfunction, turn off the product immediately and contact BLUETTI support or your local BLUETTI dealers if this manual cannot adequately explain the malfunction to you.
- Do not place the product on an unstable or inclined surface.
- Do not insert foreign objects into any port and vent of the product.
- Keep the product out of the reach of children and pets.

### Comply with applicable laws and regulations.

- The transportation, wiring, and maintenance shall comply with all applicable laws, regulations, and standards.
- User-provided materials and tools required shall meet the requirements specified in applicable laws, regulations, and relevant standards.

## Storage Instructions



- When the SoC drops to 5%, please charge the product immediately.
- Before storing the product, charge it to 40% to 60% SoC to keep it in optimal condition. In addition, power off the product and disconnect all electrical connections from it.
- Store the product in a cool and dry place, keeping it away from flammable or combustible materials and gases.
- The product can be safely stored within a temperature range of -20°C to 40°C ( -4°F to 104°F). However, if the storage duration exceeds one month, it's recommended to maintain an ideal storage temperature of around 30°C (86°F).
- Fully cycle the product every 3 months to maintain the battery's health. It's NOT recommended to store the product for extended periods of time, as it may affect its performance and overall lifespan.

 If the SoC drops to 0 (during storage or upon startup), take the following actions to safely restart the product:



- Shut down immediately.
- Charge within 48 hours.
- Keep it at an ambient temperature of 5°C to 35°C (41°F to 95°F) for 24 hours before charging. It's recommended to charge the product via an AC source.

## 2. Packing List

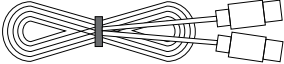
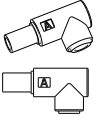
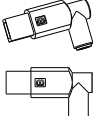
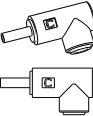
### Standard Packaging

No.	Item	Picture	Qty.
1	X20 Portable Power Bank		1
2	20V/8A MAX. DC Power Cable (DC093-DC5525, 1m/3.28ft)		1
3	20V/5A MAX. (USB-C to USB-C Cable, 1m / 3.28ft)		1
4	DC 7.9*5.6*0.9 (FOR Lenovo / IBM)		1
5	DC 11*4.5 (FOR Lenovo square head)		1
6	DC 4.0*1.7 (FOR Lenovo)		1

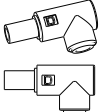
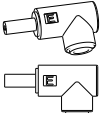
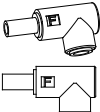
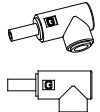
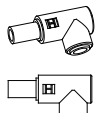
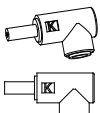
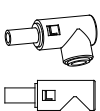
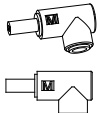
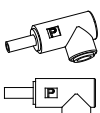

No.	Item	Picture	Qty.
7	DC 7.4*5.0*0.6 (FOR DELL)		1
8	DC 5.5*2.1 (FOR ACER)		1
9	DC 6.5*4.4 (FOR Samsung / Sony)		1
10	DC 5.0*1.0 (FOR Samsung/ Sony )		1
11	DC 7.4*5.0*0.6 (FOR HP)		1
12	DC 5.5*1.7 (FOR ACER)		1
13	DC 6.0*3.7*0.6 (FOR ASUS)		1
14	DC 5.5*2.5 (Universal type)		1
15	DC 4.5*3.0*0.6 (FOR HP)		1
16	User Manual		

### 3. Product Overview

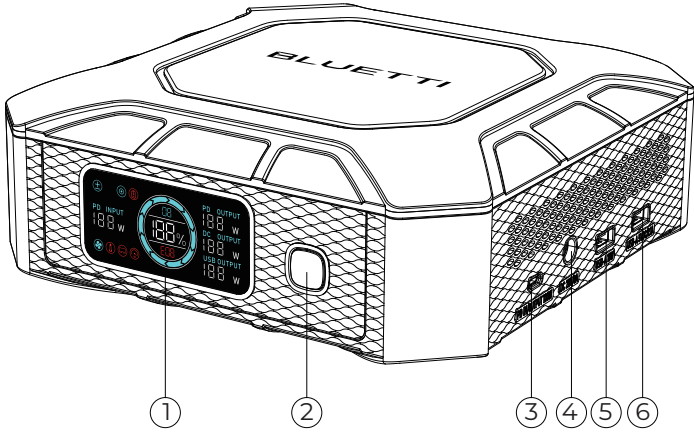

- ① LCD Display
- ② Power Button\*
- ③ Bidirectional USB-C Port (Input & Output)
- ④ DC093 Port
- ⑤ 18W USB-A Port
- ⑥ 10.5W USB-A Port

\* Its indicator stays steady green when powered on and flashes green while charging.

## 4. LCD Display

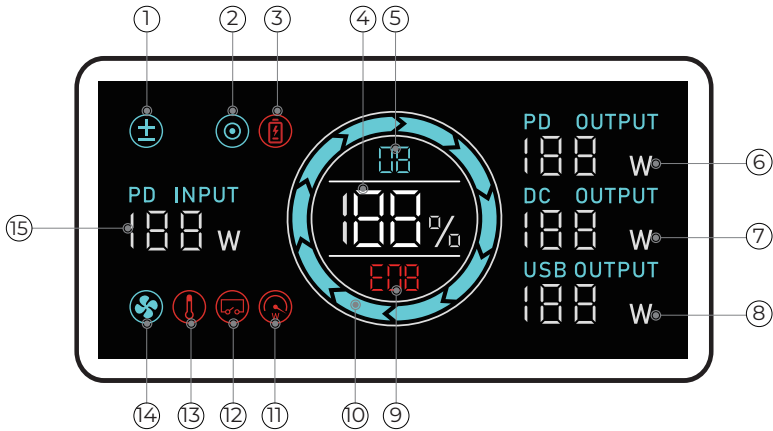

### LCD Instructions

No.	Icon	Description
①	Shallow Charge Mode	The Shallow Charge Mode is enabled to protect the battery.
②	DC Output	The DC093 port is active.
③	Low Battery Alert	The SoC drops below 5%.
④	Battery Capacity (SoC)	The remaining battery capacity.
⑤	Software Version	After startup, it displays for 3 seconds and then disappears.
⑥	USB-C Output Power	The real-time USB-C output.
⑦	DC Output Power	The real-time DC093 port output.
⑧	USB-A Output Power	The real-time total USB-A output.
⑨	Error Code	When there's a fault, it displays an error code 3 seconds after startup; otherwise, it remains blank.
⑩	Battery State of Charge (SoC)	Each bar represents 10%.
⑪	Overload Alert	The X20 is overloaded.
⑫	Short Circuit Alert	The X20 has a short circuit.
⑬	Temperature Abnormal Alert	The temperature inside the product is too high or too low. Wait for it to return to normal.
⑭	Fan Status	The fan is activated when the product's temperature is high.
⑮	USB-C Input Power	The total input power.

**Note:** To clear the short circuit and overload icons, remove all loads, then press the power button when the display is on.

## 5. Operations

### 5.1 Power ON / OFF

- **Power on:** Press and hold the power button for 3 seconds until the display and indicator light up. When the X20 is on and the display is off, press the power button once to turn it on.
- **Power off:** Press and hold the power button for 3 seconds until the display and indicator turn off.

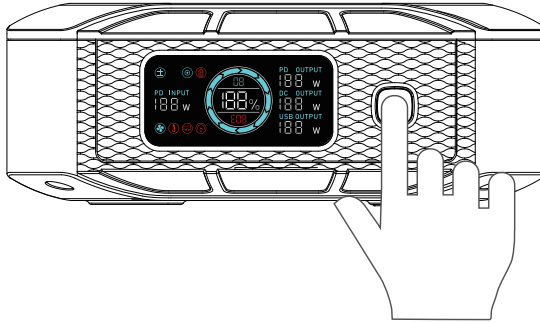

**Note:** Automatic shutdown when no output/ $<1\text{W}$  for 1 minute.

### 5.2 Charging

Plug the X20 into a standard wall outlet using the AC adapter and provided USB-C cable.



Adapter	Recharging Time
65W Adapter	About 3 hours
100W Adapter	About 2 hours

**Note:**

- The above charging time is based on PD3.0 protocol.
- While charging, the X20 cannot be turned off using the power button.
- If the X20 is fully charged and the adapter is connected, it will only recharge when the SoC falls below 95%.

## 5.3 Discharging

The X20 includes a USB-C port, 2 USB-A ports, and a 20V DC port to power your various devices.

## 5.4 Shallow Charge Mode

While the X20 device is connected to a charger for charging and being used at the same time, its SoC will be intelligently maintained in the 60% to 70% power range in order to effectively extend battery life.

To activate this mode, press the power button three times while the product is on. The (⊕) appears.

To deactivate this mode, press the power button three times, restart the product, or unplug the adapter. The (⊕) disappears.

## 6. Specifications

Item	Specs
Battery Capacity	153.6Wh / 12Ah
Cell Type	LFP
Weight	Approx. 2.3kg / 5.07lbs
Dimensions (L × W × H)	205mm × 205mm × 77mm / 8.07in × 8.07in × 3.03in
Charging Temperature	0°C to 40°C / 32°F to 104°F
Discharging Temperature	-20°C to 40°C / -4°F to 104°F
Storage Temperature	-20°C to 40°C / -4°F to 104°F
Working Humidity	10% to 90%
Noise	45dB
<b>DC Output</b>	
DC093 Port	20VDC, 8A, 160W Max.
USB-A	5VDC, 2.1A, 10.5W Max.
USB-A (QC 3.0)	5VDC, 3A; 9VDC, 2A; 12VDC, 1.5A; 18W Max.
USB-C (PD3.0 / QC3.0+ / SCP / FCP / AFC)	5V / 9V / 12V / 15V / 20VDC, 3A; 20VDC / 5A ; 100W Max (eMarker chip built-in)
<b>DC Input</b>	
Interface	USB-C
Power	100W Max.
Current	5A Max.
Voltage	5V to 20V

## 7. Troubleshooting

The error code appears on the display when the product malfunctions. Please refer to the table below for helpful guidance.

Error Code	Description	Troubleshooting
E01 / E06	USB-C port cannot be used for discharging.	Restart
E02 / E07	DC093 port cannot be used for discharging.	Restart
E03 / E09	USB-A ports cannot be used for discharging.	Restart
E04 / E05 / E08 / E10	X20 cannot charge and discharge.	Restart
E11	X20 fails to supply power.	Restart
Others	/	Please contact BLUETTI support for assistance.

## Appx. 1 Abbreviations

- DC: Direct Current
- PD: Power Delivery
- SoC: State of Charge

### Customer Service

Tel: **800-200-2980** (Monday to Sunday 9:00-17:00)

Email: [sale@bluettipower.com](mailto:sale@bluettipower.com) (Pre-sales),

[service@bluettipower.com](mailto:service@bluettipower.com) (After-sales)

### SHENZHEN POWEROAK NEWENER CO., LTD.

Add: F19, BLD No.1, Kaidaer, Tongsha Rd No.168,

Xili Street, Nanshan, Shenzhen, China

## Warranty Card

Manufacture Date .....

Sale Date .....

File No. ....

Manufacturer .....

## Warranty Instructions

1. 24-months warranty
2. After-Sale-Service mailbox: [service@bluettipower.com](mailto:service@bluettipower.com)
3. Following situations will go against the warranty terms:
  - A. Any problems, malfunction or damages due to incorrect using methods or caused by unauthorized disassembly or repair.
  - B. The damage caused by force majeure, fire and other extreme abnormal conditions.
  - C. Without the warranty card or the card records is not clear, complete, or without the sales company seal



**BLUETTI**

## Certificate

Inspector: \_\_\_\_\_

QC: \_\_\_\_\_

Just Power On

P/N:17.0303.0784-02A2