

# B210P

# Expansion Battery

## User Manual v1.0

Please read this manual carefully before use and keep it for future reference.



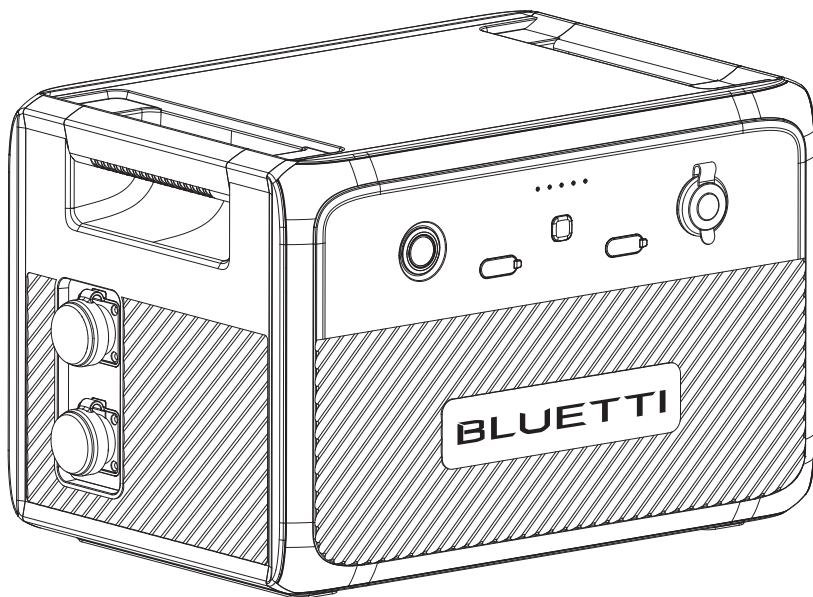

### **⚠ Warning**

1. Charge the unit before first use.
2. Do not use solar panels with open circuit voltage higher than 60V. Solar input voltage range for the unit is 11V-60VDC.
3. Charge the unit immediately when the SoC drops below 5%. If the SoC drops to 0, power off the unit and charge it for at least 30 minutes before restarting.
4. If not used for more than 3 months, charge the unit to 40%-60% SoC and store it with the power off. For optimum battery life, discharge and charge the unit every 3 months.

## Thank You!

Thank you for making BLUETTI a part of your family.

From the very beginning, BLUETTI has tried to stay true to a sustainable future through green energy storage solutions while delivering an exceptional eco-friendly experience for our homes and our world.

That's why BLUETTI makes its presence in 100+ countries and is trusted by millions of customers across the globe.



### Notice

BLUETTI's products, services, and features are subject to the agreed-upon terms and conditions during purchase. Please note that some products, services, or features described in this manual may not be available under your purchase contract. Unless otherwise specified in the contract, BLUETTI makes no representations or warranties of any kind, express or implied, with respect to the contents of this manual.

The contents of this manual are subject to change without notice. Please get the latest version from: <https://www.bluettipower.com/pages/user-guides>

If you have any questions or concerns about this manual, please contact BLUETTI support for further assistance.

# Contents

1	Safety Instructions	05
2	Packing List	09
3	Product Overview	11
4	Power ON / OFF	12
5	Charging	12
6	Discharging	15
7	AC240P + B210P Expansion Connection	15
8	BLUETTI App	17
9	Specifications	18
10	Troubleshooting	19
11	FAQ	20

# 1. Safety Instructions

Read this manual for instructions on the proper use and safety information for the product. The safety instructions provided herein are for illustrative purposes that include but are not limited to those listed in this manual. Actual operation shall comply with all applicable safety standards. If you have any questions, feel free to contact BLUETTI support or your local BLUETTI dealers.

## 1.1 Statement

To ensure a safe operation, it's crucial to observe and adhere to the following conditions:

- Always operate or store the product in the conditions specified in this manual.
- Avoid unauthorized disassembly, component replacement, or modification of software codes.

**⚠** BLUETTI shall not be liable for damages resulting from the following circumstances:

- Force majeure events such as earthquakes, fires, storms, floods, or mudslides.
- Damage caused by the customer's own transportation.
- Damage resulting from inadequate storage conditions as specified in the manual.
- Damage caused by customer negligence, improper operation, or intentional actions.
- System or hardware damage caused by third parties or customers, including but not limited to improper handling and installation not in accordance with the instructions in this manual.

## 1.2 General Requirements

INSTRUCTIONS PERTAINING TO RISK OF FIRE, ELECTRIC SHOCK, OR INJURY TO PERSONS  
IMPORTANT SAFETY INSTRUCTIONS

### **WARNING:**

When using this product, basic precautions should always be followed, including the following:

- Read all the instructions before using the product.
- To reduce the risk of injury, close supervision is necessary when the product is used near children.
- Do not put fingers or hands into the product. And do not insert foreign objects into any ports of the product.

- Use of an attachment not recommended or sold by the manufacturer may result in a risk of fire, electric shock, or injury to persons.
- To reduce the risk of damage to the electric plug and cord, pull the plug rather than the cord when disconnecting the product.
- Do not use a battery pack or appliance that is damaged or modified, as they may exhibit unpredictable behavior resulting in fire, explosion, or personal injury.
- Do not operate the product with a damaged cord or plug, or a damaged output cable.
- Do not attempt to replace the internal battery or any other component of the product by anyone other than authorized personnel. There are no end-user serviceable components. Do not disassemble the product, take it to a qualified service person when service or repair is required. Incorrect reassembly may result in a risk of fire or electric shock.
- To reduce the risk of electric shock, unplug the product from the outlet before attempting any instructed servicing.
- **WARNING - RISK OF EXPLOSIVE GASES.** To reduce the risk of battery explosion, follow these instructions and those published by the battery manufacturer and manufacturer of any equipment you intend to use in the vicinity of the battery. Review cautionary markings on these products and engines.
- **PERSONAL PRECAUTIONS**
  - a. Wear complete eye protection and clothing protection. Avoid touching eyes while working near the battery.
  - b. Never smoke or allow a spark or flame in the vicinity of the battery or engine.
  - c. Be extra cautious to reduce the risk of dropping a metal tool onto the battery. It might spark or short-circuit the battery or other electrical parts which may cause an explosion.
- When charging the internal battery, work in a well ventilated area and do not restrict ventilation in any way.
- Under abusive conditions, liquid may be ejected from the battery; avoid contact. If contact accidentally occurs, flush with water. If liquid contacts eyes, additionally seek medical help. Liquid ejected from the battery may cause irritation or burns.
- Do not expose the product to fire or excessive temperature. Exposure to fire or temperature above 80°C (176°F) may cause an explosion.
- Have servicing performed by a qualified repair person using only identical replacement parts. This will ensure that safety is maintained.

- Do not stack anything on top of the product while in storage or while in use. Do not move the product while operating as vibrations and sudden impacts may lead to poor connections to the hardware inside.
- In case of fire, use only a dry powder fire extinguisher appropriate for the product.
- **WARNING - RISK OF ELECTRIC SHOCK.** Never use the product to supply power tools to cut or access live parts or live wirings, or materials that may contain live parts or live wirings inside, such as building walls, etc.

### 1.3 Handling Requirements

During transportation or storage, take care to avoid dropping, violently impacting, or tilting the product as it may result in internal damage. If necessary, use mechanical assistance such as carts or adjustable height workbenches to ensure safe handling.

#### Recommended number of people based on the weight of product



Weight	Number of people
<18kg (39.7lbs)	1
18kg~32kg (39.7lbs~70.5lbs)	2
32kg~55kg (70.5lbs~121.3lbs)	3
>55kg (121.3lbs)	4 or a cart

### 1.4 Storage Instructions

- When the SoC drops to 5%, please charge the product immediately.
- Before storing the product, charge it to 40% to 60% SoC to keep it in optimal condition. In addition, power off the unit and disconnect all electrical connections from it.
- Store the product in a cool and dry place, keeping it away from flammable or combustible materials and gases.
- The product can be safely stored within a temperature range of -20°C to 45°C (-4°F to 113°F). However, if the storage duration exceeds one month, it's recommended to maintain an ideal storage temperature of around 30°C (86°F).
- Fully cycle the product every 3 months to maintain the battery's health. It's NOT recommended to store the unit for extended periods of time, as it may affect its performance and overall lifespan.

**If the SoC drops to 0 (during storage or upon startup), take the following actions to safely restart the product:**

- Shut down immediately.
- Charge within 48 hours.
- Keep it at an ambient temperature of 5°C to 35°C (41°F to 95°F) for 6 hours before charging. It's recommended to charge the product via an AC source. If charging via solar energy, ensure that your solar system provides an output of more than 100W.

  The symbol displayed is intended to remind you to read the instructions in the literature accompanying the product before operation and maintenance.

- Connect the product to a socket-outlet that has an earthing connection using the power cord provided.
- The socket-outlet should be installed near the product and easily accessible for safety purposes.
- Never dispose of a battery by throwing it into fire or a hot oven, or by mechanically crushing or cutting it, as these may cause it to explode.
- Avoid leaving batteries in extremely high-temperature environments, as this can result in an explosion or the leakage of flammable liquid or gas.
- The battery subjected to extremely low air pressure may result in an explosion or the leakage of flammable liquid or gas.
- Attention should be drawn to the environmental aspects of battery disposal.
- Please refer to the information on the exterior bottom enclosure for electrical and safety information before installing or operating the apparatus.



#### **SAVE THESE INSTRUCTIONS**

 **BLUETTI shall not be liable for any equipment damage caused by the violation of the above instructions.**

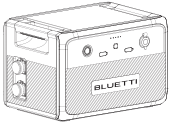
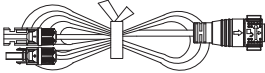
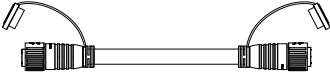

## 2. Packing List

### Standard Accessories

Item	Picture	Qty.
B210P Expansion Battery		1
Solar Charging Cable		1
Battery Expansion Cable		1
Product Documentation		1
Warranty Card		1

### Optional Accessories

(Available on official BLUETTI website)

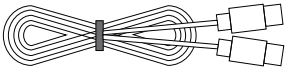
Item	Picture
USB-C to USB-C Cable (output) (100W Max. Compatible with USB-C devices.)	

---

Lead-acid Battery Charging Cable  
(Charge the B210P via a lead-acid battery.)

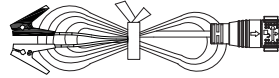

---

Car Charging Cable  
(Charge B210P via the car's cigarette lighter port.)

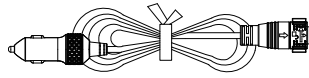

---

PV Voltage Regulator  
(Convert high solar panel voltage to a suitable level for battery charging.)

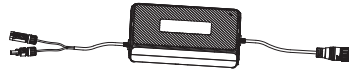

---

12V DC Power Cable  
(Charge 12V devices with DC5521 ports, such as routers, GPS, etc.)

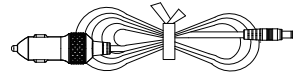

---

T500 / T500S AC Adapter  
(Charge the B210P via a wall outlet.)



---

AC Power Cable  
(Work with the AC adapter.)

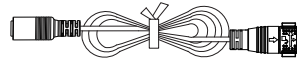

### 3. Product Overview

The BLUETTI B210P Expansion Battery is a versatile and powerful battery pack with a capacity of 2,150Wh. It is designed to work in tandem with the BLUETTI AC240P inverter, which allows you to expand your battery capacity to 10,443Wh by connecting up to four B210P batteries in parallel.

The B210P can also work independently as a power source for specific DC appliances. With USB-A, USB-C, and 12V cigarette lighter outputs, the B210P is compatible with a wide range of devices, from laptops and smartphones to car fridges and camping heaters. Additionally, the B210P offers a variety of charging options, including solar, car cigarette lighter, 12V lead-acid battery, or power adapter, so no matter where you are, you can always keep the B210P charged and ready to go.

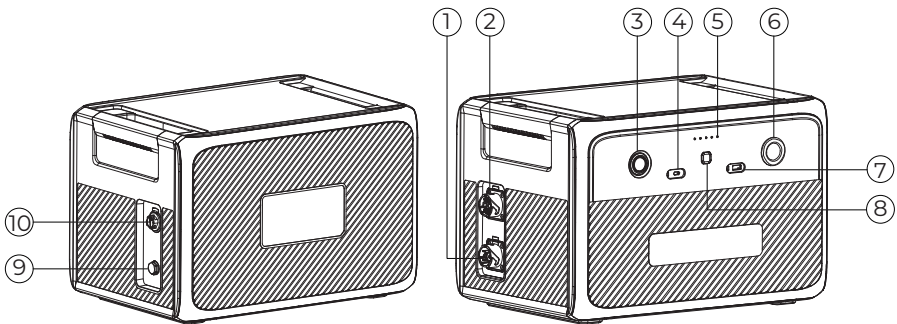

① Battery Expansion Port

② Battery Expansion Port

③ Power Button

④ USB-C Port

⑤ SoC/Alarm Indicator

⑥ Cigarette Lighter Port

⑦ USB-A Port

⑧ DC Power Button

⑨ Bleed Valve

⑩ Input Port

## 4. Power ON / OFF

To power on the B210P, press and hold the Power Button for about 2 seconds, the SoC indicator will light up.

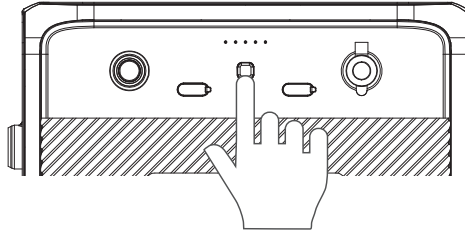

The B210P has a built-in feature that allows it to power on and starts charging as soon as it detects input from a connected power source (e.g., wall outlet, solar panel, etc.).

To restart the B210P, simply press and hold the Power Button for more than 2 seconds to shut down all outputs and turn off the unit. Press the button again to turn it back on.

**Note:** To completely turn off the B210P, please disconnect all power sources, such as solar panels and adapter.

## 5. Charging

The B210P can be charged using a standard wall outlet, solar energy, a car power source, or in combination with the AC240P power station.

### Notice:

- Double-check that all cables are firmly plugged in.
- Avoid getting plugs and ports wet to prevent any potential damage.

### 5.1 Wall Outlet

Simply plug the B210P into a standard wall outlet to start charging. It typically takes about 4.8-5.3 hours for a full charge at an ambient temperature of 25°C (77°F), and the charging automatically stops once the battery is fully topped up.

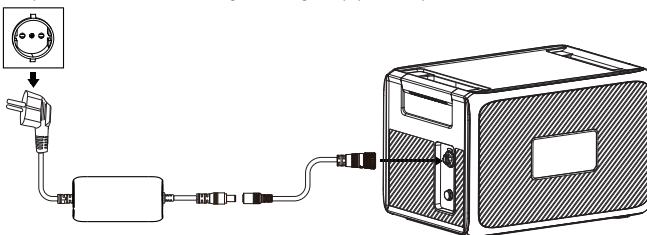

## 5.2 Solar Panel(s)

Connect the solar panel(s) to B210P via the solar charging cable. With a continuous input of 500W, B210P will automatically stop charging in 4.5-5 hours. However, please note that the charging time may vary based on weather conditions, sunlight intensity, panel orientation, and other variables.

**Note:** Make sure your solar panel(s) meet the following requirements:

Voc: 11V-60V

Current: 10A Max.

Power: 500W Max.

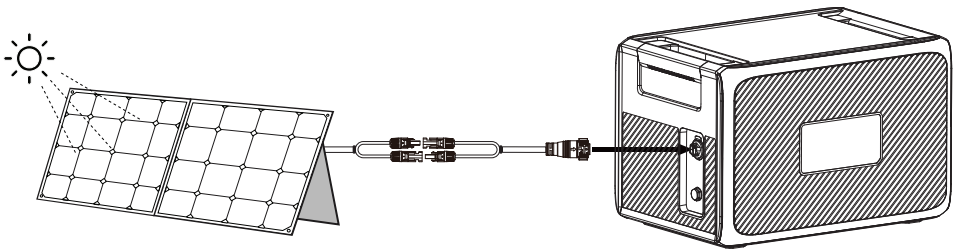

### ⚠ Notice:

· If you unplug the solar charging cable from the B210P and you're not using any DC outputs, the B210P will automatically shut down after about 4 hours.

**For solar panel(s) with an open circuit voltage between 60V and 145V, you can still use them to charge the B210P. Simply connect the solar panel(s) to the B210P via the PV Voltage Regulator, and you can enjoy seamless and hassle-free solar charging.**

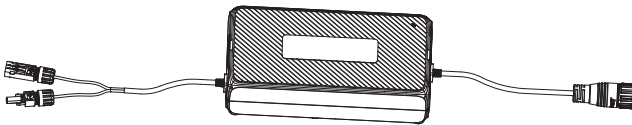

## 5.3 Car Outlet

Connect the B210P to the vehicle's 12V cigarette lighter port via the car charging cable. The B210P also automatically stops charging when it's fully charged.

**Note:** Make sure your vehicle meets the following conditions for charging:

- The vehicle is capable of supplying power.
- The vehicle's engine is running during the charging process.

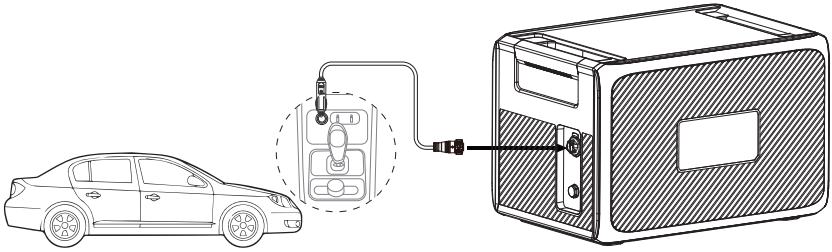

**Attention:**

The B210P has a low voltage disconnect function designed to protect your vehicle's battery during charging. If the input voltage drops below 8V, the unit will automatically stop charging to prevent over-discharging and potential damage to the battery.

### 5.4 AC240P Power Station

To charge both the AC240P and B210P simultaneously, connect the two units using the battery expansion cable provided. Then, plug the AC240P into a standard wall outlet.

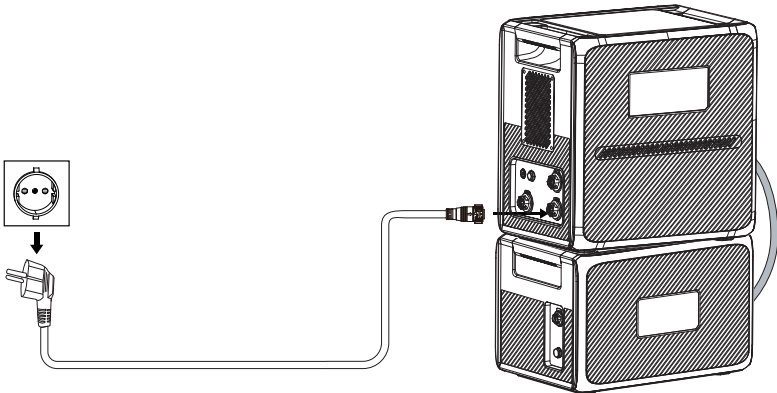

**Attention:**

It's recommended to fully charge the B210P before connecting it to AC240P.



## 6. Discharging

The B210P is equipped with three DC outlets, including a USB-C port, a USB-A port, and a cigarette lighter port, which allow you to charge a variety of devices.

Port	Picture	Specifications	Compatible Loads
Cigarette Lighter Port		12V / 10A	12V DC appliances up to 120W power. e.g. car refrigerator, air conditioner
USB-A		QC 3.0, 18W Max.	Mobile phones and other small loads.
USB-C		PD 3.0, 100W Max.	Mobile phones, laptops, etc.

**Note:** To ensure optimal performance, avoid short-circuiting the ports and keep them dry during use or storage. Additionally, do not block or cover the ports while ensuring proper ventilation.

## 7. AC240P + B210P Expansion Connection

The AC240P is compatible with up to 4 B210P units, providing an impressive total capacity of up to 10,443Wh. To connect them:

Step 1: Make sure both AC240P and B210P are turned off.

Step 2: Connect them using the battery expansion cable.

Step 3: Power the AC240P on and the B210P turns on automatically. The  displays on the AC240P's screen.



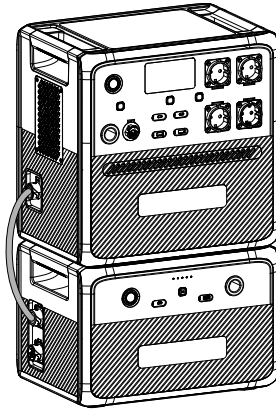

AC240P + 1 × B210P

If you want to add more B210P units, please set up the system as shown.

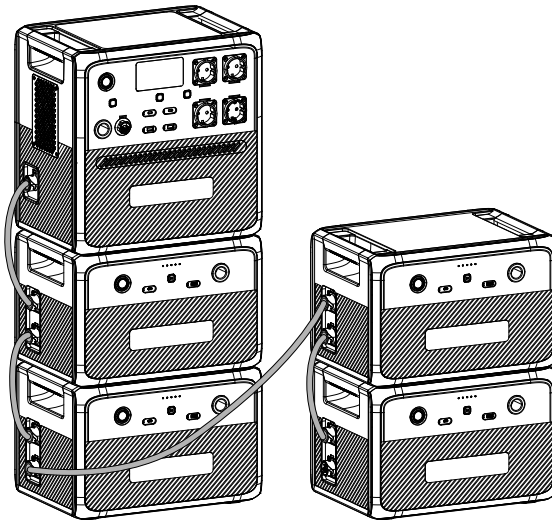

AC240P + 4 × B210P

 Attention:

The AC240P connects to the upper battery expansion port of B210P.



## 8. BLUETTI APP

Scan the QR code below or search "BLUETTI" in the App Store or Google Play to download the BLUETTI App.



### Attention:

Only when connected with the AC240P can you use the app to view the operating status of the B210P and upgrade its firmware over-the-air (OTA). For detailed instructions on how to use the app to manage B210P, please refer to the BLUETTI App User Guide.

## 9. Specifications

Model	B210P
Battery Capacity	2,150Wh (42Ah)
Cell Type	Lithium Iron Phosphate (LiFePO <sub>4</sub> , LFP)
DC Input	500W Max.
Weight	27.9kg / 61.5lbs
Dimensions (L × W × H)	416.6mm × 282.4mm × 269.5mm / 16.4in × 11.1in × 10.6in
Charging Temperature	0°C to 40°C / 32°F to 104°F
Discharging Temperature	-20°C to 40°C / -4°F to 104°F
Storage Temperature	Up to 1 month: -20°C to 45°C / -4°F to 113°F Up to 3 months: -20°C to 30°C / -4°F to 86°F Up to 12 months: -20°C to 25°C / -4°F to 77°F
Working Humidity	10% to 90%
Ingress Protection (IP) Rating	IP65
Noise	40dB Max.
Working Altitude	2,000m / 6,561ft
DC Output	
Cigarette Lighter Port × 1	12VDC / 10A
USB-A × 1	18W Max. (QC3.0: 5V / 3A; 9V / 2A; 12V / 1.5A)
USB-C × 1	100W Max. (PD3.0: 5/9/12/15/20V 3A; 20V/5A, with built-in EMark chip)
T500 / T500S Input	
Power	470W Max.
Voltage	58.8VDC
Current	8A Max.
DC Input	
Interface	2-pin Aviation Socket
Power	500W Max.
Voltage	11VDC to 60VDC
Current	10A Max.
Battery Expansion Port × 2	
Voltage	51.2VDC
Current	60A Max.

## 10. Troubleshooting

In case of a B210P failure, the Power Button or DC Power Button light will flash. If the latter flashes, press and hold it for about 3 seconds, and the SoC indicator will start flashing. Please refer to the table below for helpful guidance.

Flashing Indicator	Description	Troubleshooting
Power Button Light	BMS failure	Power off the B210P, and disconnect all electrical connections.
Second SoC Indicator	PV input overvoltage or charging temperature too high	Ensure that PV input voltage is within the range of 11VDC to 60VDC; when the temperature is too high, wait for it to cool down before charging.
Third SoC Indicator	DC output overload	Check if the power consumption of your devices is too high. Reduce the load if necessary.
Fourth SoC Indicator	DC output overcurrent	Check if the power consumption of your devices is too high. Reduce the load if necessary.
Fifth SoC Indicator	Operating temperature too high or too low	Recommended charging temperature: 0°C to 40°C / 32°F to 104°F Recommended discharging temperature: -20°C to 40°C / -4°F to 104°F
Others	/	Please contact BLUETTI support for assistance.

## 11. FAQ

**Q1: Can I use third-party solar panels to charge this product?**

**A:** Yes, you can. However, make sure your solar panels have an open circuit voltage of 11V-60V and are equipped with MC4 connectors. It's also important not to mix different types of solar panels.

**Q2: Can it charge and discharge at the same time?**

**A:** Yes. It supports pass-through charging. The B210P comes with the premium LiFePO<sub>4</sub> battery and proprietary Battery Management System to ensure that it can charge and discharge at the same time.

**Q3: Why is the charging power often too low?**

**A:** B210P has a built-in intelligent BMS that automatically adjusts the charging power in response to the battery temperature and SoC, thus protecting the battery and extending its service life.

**Q4: How to upgrade the firmware of B210P?**

**A:** Connect it to AC240P, pair the system with BLUETTI App, and you can upgrade the firmware including ARM, DSP, HMI and BMS over-the-air (OTA).

**Q5: Why does the B210P automatically turn itself on?**

**A:** When the B210P detects input from connected power sources such as solar panels and wall outlets, it will automatically turn on and start charging.

**Q6: If I forget to turn off the B210P, will it automatically power off by itself?**

**A:** If the B210P is not connected to any power sources or electrical appliances, it'll automatically turn off after 4 hours of inactivity.

**For more information, please visit:**



@ BLUETTI Support

@ BLUETTI Official



@bluetti\_official



@ bluetti.inc



@ bluetti\_inc



sale-eu@bluettipower.com

**EU REP**

Company: POWEROAK GmbH

Address: Lise-Meitner-Str. 14 28816

Stuhr Germany

Mail: logi@bluetti.de

**UK REP**

Company: POWEROAK ENERGY UK CO.,LTD

Address: Unit 2 NorthGate, Bolsover Business Park,

Woodhouse Lane Chesterfield England, S44 6BD

Mail:poweroak.eu@bluetti.com

### **Customer Service(DE)**

Tel: +49 8006273016

Service Hours: Monday to Friday

9:00 - 17:00 (local time)

### **Customer Service(UK)**

Tel: +44 8000472906

Service Hours: Monday to Friday 9:00 - 17:00

(local time)

**SHENZHEN POWEROAK NEWENER CO., LTD.**

Address: F19, BLD No.1, Kaidaer, Tongsha Rd No.168,

Xili Street, Nanshan, Shenzhen, China





**BLUETTI**

「 」

「 」

## **Certificate**

Inspector: \_\_\_\_\_

QC: \_\_\_\_\_

Just Power On