



THE POWER IS ON

Uninterruptible power supply UPS

**COVER JR**

**10 – 15 – 20 kVA**

**3:3 / 3:1**

User Manual

The content of this document is the copyright of the publisher and may not be reproduced without prior permission. The right to modify the design and specifications is reserved without prior notice.

Copyright 2020  
COMEX S.A.  
All rights reserved.

## Table of contents

1.	Safety rules.....	1
2.	Transport, unpacking the UPS .....	3
3.	Appearance and connection .....	4
3.1.	UPS rear panel.....	4
3.2.	Connection of the remote REPO switch.....	4
3.3.	Connecting communication to the External Service Bypass EMBS. ....	4
3.4.	Connection of communication options.....	5
3.5.	Power connection - configuration 3:3 .....	5
3.6.	Power connection - configuration 3:1 .....	5
4.	LCD display operation .....	6
4.1.	Main display window .....	6
4.2.	UPS control window .....	7
4.3.	Measure window.....	9
4.4.	UPS configuration window (Setting) .....	11
4.5.	Information window.....	13
4.6.	Alarm window .....	13
5.	Audible alarms and event codes.....	14
5.1.	Audible alarms.....	14
5.2.	Warning codes.....	14
6.	UPS operations.....	15
6.1.	Turn on the UPS from the mains.....	15
6.2.	UPS shutdown .....	15
6.3.	Turn on the UPS from the battery .....	15
6.4.	Switching UPS to the Maintenance Bypass mode .....	16
6.5.	Switching the UPS from Maintenance Bypass mode .....	16
6.6.	Installing the software.....	16
6.7.	Working conditions .....	16
6.8.	The storage conditions.....	17
6.9.	Battery change .....	17

## 1. Safety rules

This manual provides information on the safe use of the UPS. Before unpacking and installing the UPS, read its contents and follow its instructions.

	<b>FULFILLED STANDARDS - EXECUTION</b>
EN 62040-3	Uninterruptible Power Systems (UPS): Methods for determining the properties and test requirements.

	<b>FULFILLED STANDARDS - ELECTROMAGNETIC COMPATIBILITY</b>
EN 62040-2 :2006 C3	Guaranteed Power Systems (UPS): Electromagnetic Compatibility.
EN 61000-2-2 :2002	Electromagnetic Compatibility (EMC): Environment. Compatibility levels for conducted low-frequency disorders and signaling in public low-voltage power systems.
EN 61000-4-2 :2009	Electromagnetic Compatibility (EMC): Testing and measurement methods - electrostatic discharge immunity test.
EN 61000-4-3 :2006 +A1 :2008 +A2 :2010	Electromagnetic Compatibility (EMC): Testing and measurement methods - Radio frequency electromagnetic field immunity test.
EN 61000-4-4 :2004 +A1 :2010	Electromagnetic Compatibility (EMC): Testing and Measurement Methods - Testing of immunity to a series of fast electrical transients.
EN 61000-4-5 :2006	Electromagnetic Compatibility (EMC): Testing and Measurement Methods - Surge Immunity Test.
EN 61000-4-6 :2009	Electromagnetic Compatibility (EMC): Test and Measurement Methods - Immunity to conducted disturbances, induced by radio frequency fields.
EN 61000-4-8 :2010	Electromagnetic Compatibility (EMC): Testing and measurement methods - Testing of resistance to magnetic field at the frequency of the power grid.
The device complies with the Directive 2004/108 / EC (EMC).	

	<b>FULFILLED STANDARDS - SAFETY</b>
EN 62040-1:2008	Uninterruptible Power Systems (UPS): General requirements and requirements for UPS safety.
EN 60950-1:2006	Information technology devices. Security.
IEC 60417	Symbols used on devices
The device complies with the 2006/95 / EC (LVD) directive.	

- Keep these operating instructions! The manual contains important instructions on the use of the UPS that should be followed during installation and use of the UPS device and batteries.
- Condensation may occur if the power supply is cold and is brought into a warm place. Therefore, you should wait at least 2 hours until it starts up.
- To reduce the risk of electric shock, the UPS should be installed in a pollution-free room with adequate temperature and humidity. The ambient temperature must not exceed 40 ° C.
- Do not install the power supply in a place exposed to direct sunlight or other heat sources.
- Do not connect devices that can overload the UPS output, e.g. laser printers, electric heaters, etc.
- Cables should be connected and arranged in such a way that no one can accidentally step on or disconnect them.
- The UPS must be connected to a wall outlet with a working protective earth (GND).
- Do not block the ventilation openings on the UPS. Make sure the vents are exposed and there is a minimum of 25cm free space for ventilation.
- The UPS power socket should be protected with an appropriate overcurrent switch.
- The UPS has its own battery power source, so there may be voltage at the output sockets even though the UPS is not connected to the mains.
- Battery service should be performed by trained personnel who are knowledgeable about battery operation and take appropriate precautions during its use.
- If it is necessary to replace the battery, use batteries with the same number and parameters, i.e. rated voltage, capacity and dimensions.

---

***ATTENTION! Do not throw batteries into fire. The battery may explode.***

---

---

***ATTENTION! Do not open or mutilate the battery. Released electrolyte is harmful to the skin and eyes. It can be toxic.***

---

- The battery can present a risk of electric shock. The following precautions should be taken when working with batteries:
  - Remove watches, wedding rings and other metal objects from your hand.
  - Use tools with insulated handles.
  - Wear rubber gloves and boots.
  - Do not lay tools or metal parts on top of the battery.
  - Disconnect the battery charging source before connecting or disconnecting the battery terminals.
- Make sure the battery is not inadvertently grounded. If present, remove the source of ground fault. Contact with any part of a grounded battery can result in electric shock.

## 2. Transport, unpacking the UPS

Check carefully that the carton and the contents are not damaged. If any damage is found, immediately inform the shipping company and the power supply distributor.

Do not throw away the UPS packaging.

1. If no damage is found, carefully open the carton.
2. Unpack all protective elements (sponges, fillers).
3. Gently remove the UPS from the protective film and place it on a clean, flat and stable surface.

---

*To prevent mechanical damage, shock and impact, only ship the UPS in its original packaging.*

---

### 3. Appearance and connection

#### 3.1. UPS rear panel

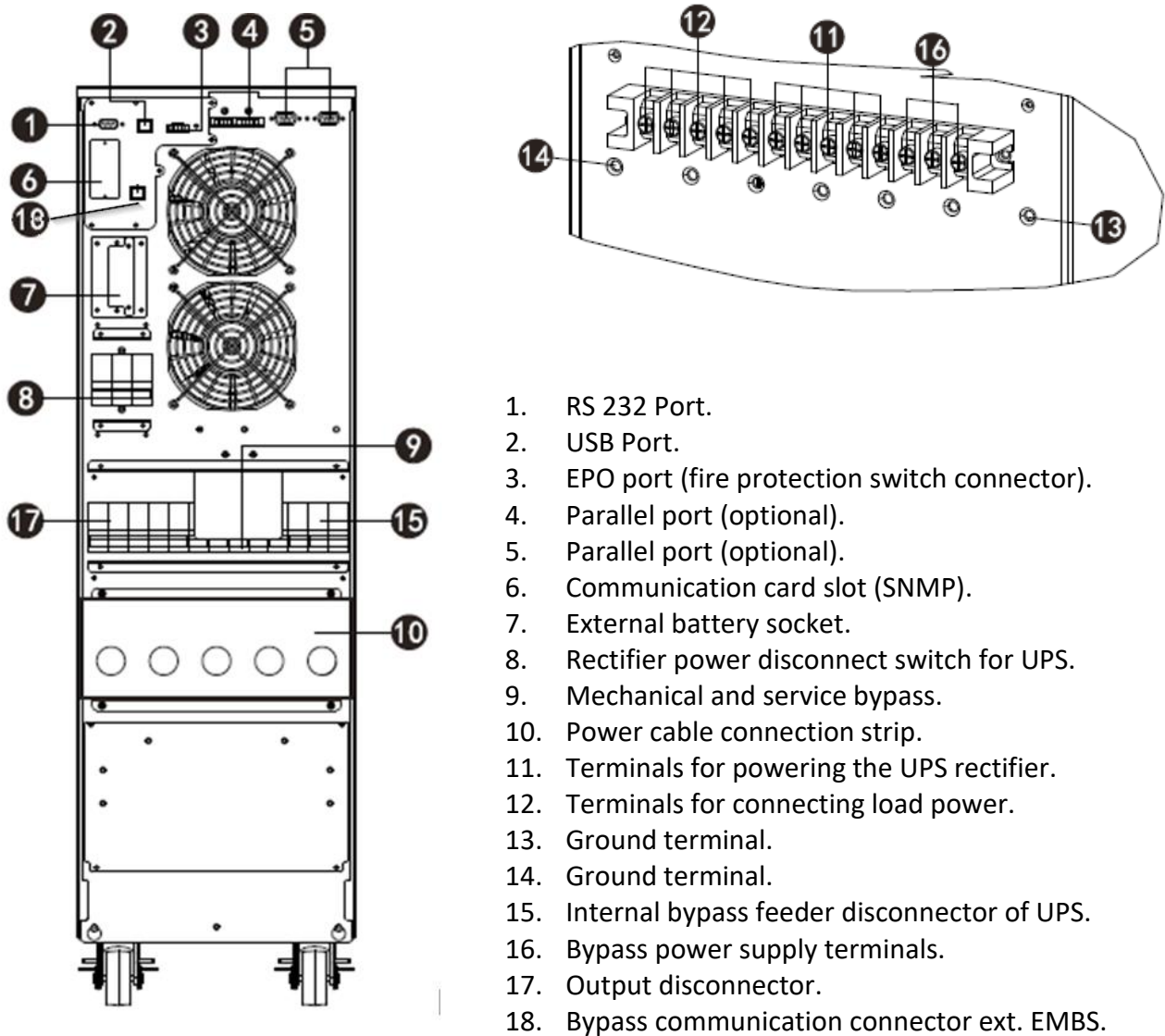

Fig. 1 UPS COVER JR 10 - 20K

#### 3.2. Connection of the remote REPO switch

The UPS is equipped with an EPO port for connecting the Remote Emergency Power Off (REPO) switch. The EPO port is configured as NC (normally closed), the activation of EPO occurs by breaking the connection between Pin 1 and Pin 2 (removal of the jumper).

#### 3.3. Connecting communication to the External Service Bypass EMBS.

The UPS is equipped with an EMBS connector, enabling communication to be connected to the External Service Bypass, in order to enable the inverter to be turned off while operating on the External Bypass. It is an NC (normally closed) port that is activated by breaking the connection between Pin 1 and Pin 2 (removing the jumper). Activating the port turns off the inverter and blocks the possibility of its activation.

### 3.4. Connection of communication options.

The UPS has two communication ports:



Intelligent Slot (SNMP)

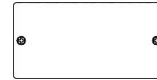

To enable automatic management and monitoring of the UPS, connect the USB cable supplied with the UPS, on one side to the USB socket on the UPS and on the other side to the USB socket on the computer. The software provided with the UPS allows you to automate the processes of turning on / off the receivers connected to the UPS depending on the events that occur on the UPS (e.g. power failure, low battery level, overload, etc.). The software also allows for ongoing monitoring and logging of UPS event history.

The UPS also has a slot for additional cards, which enables retrofitting with an SNMP network card for remote communication via the network.

### 3.5. Power connection - configuration 3:3

*NOTE: UPS operation configuration may only be changed by an authorized service!*

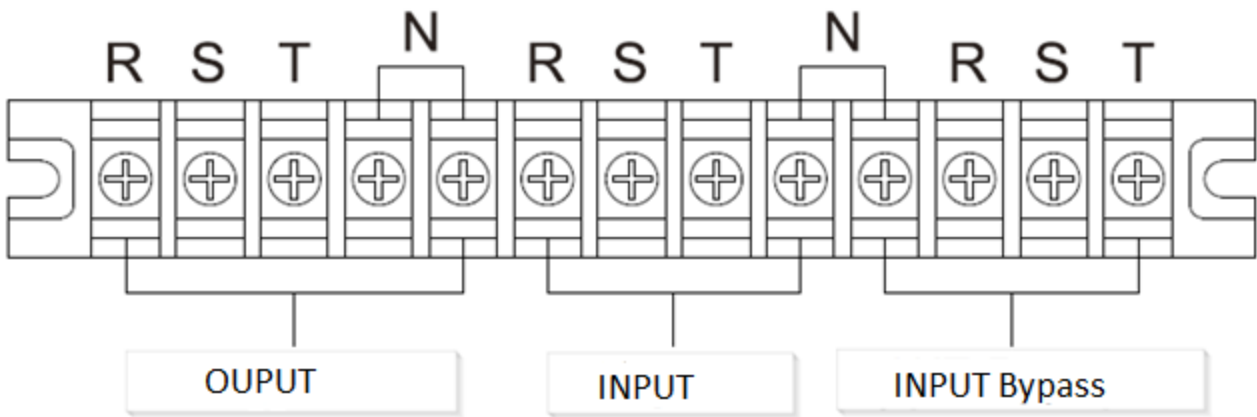

Fig. 2 Terminal for connecting the power supply for COVER JR 10 - 20K configuration 3: 3 phase

### 3.6. Power connection - configuration 3:1

*NOTE: UPS operation configuration may only be changed by an authorized service!*

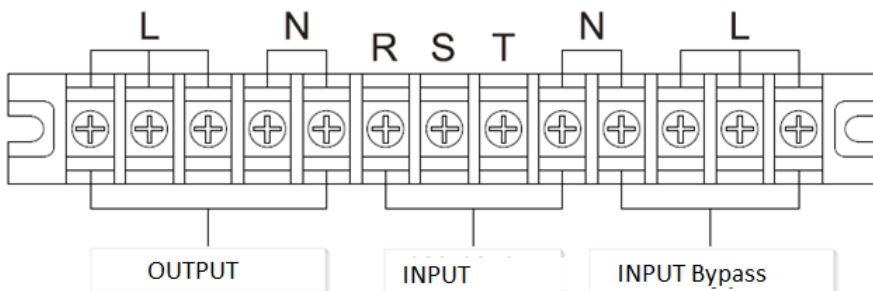

Fig. 3 Power supply terminal for COVER JR 10 - 20K configuration 3: 1 phase

## 4. LCD display operation

The PSU is equipped with a color LCD touch panel. Below is a diagram showing the possibilities and the location of the various information available in the display menu.

For 3: 3 and 3: 1 UPS configurations there are differences in the number of displayed output phases and bypass phases.

The screens below show a 3: 3 configuration. For a 3: 1 configuration, only 1 Output Phase and Bypass are displayed.

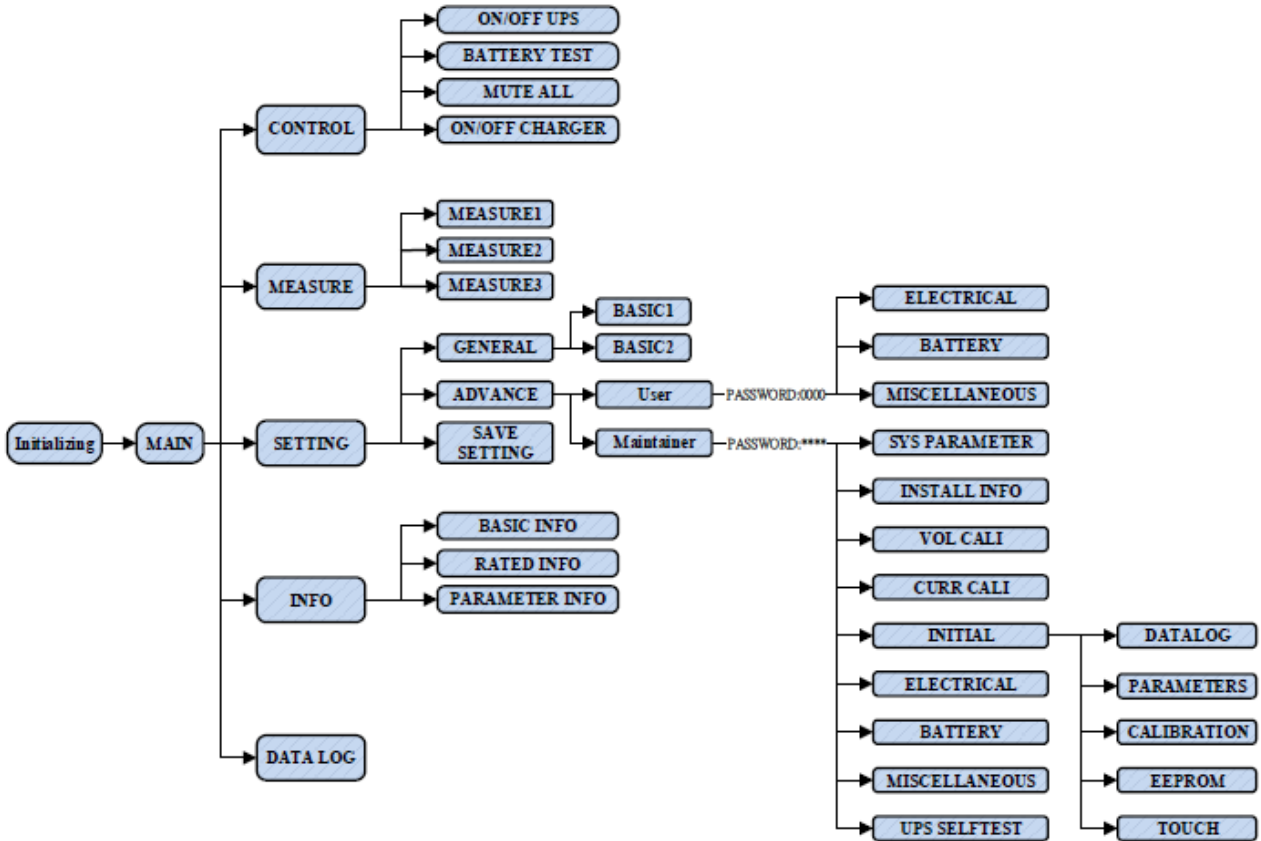

### 4.1. Main display window

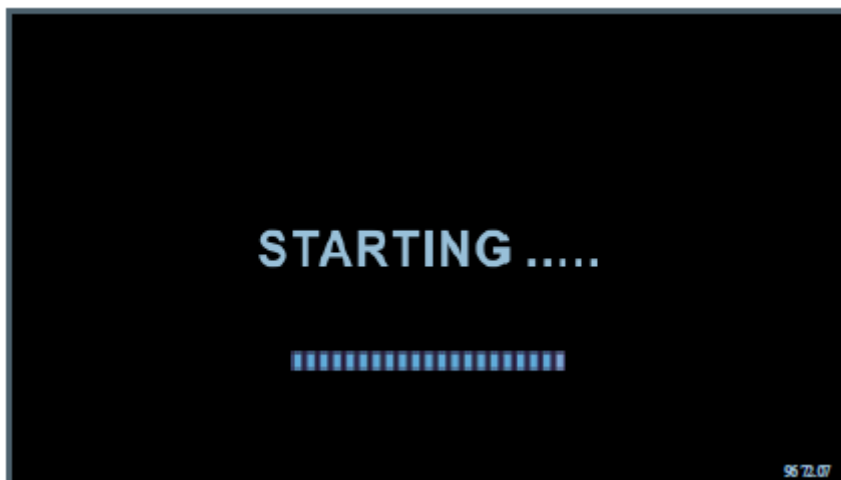



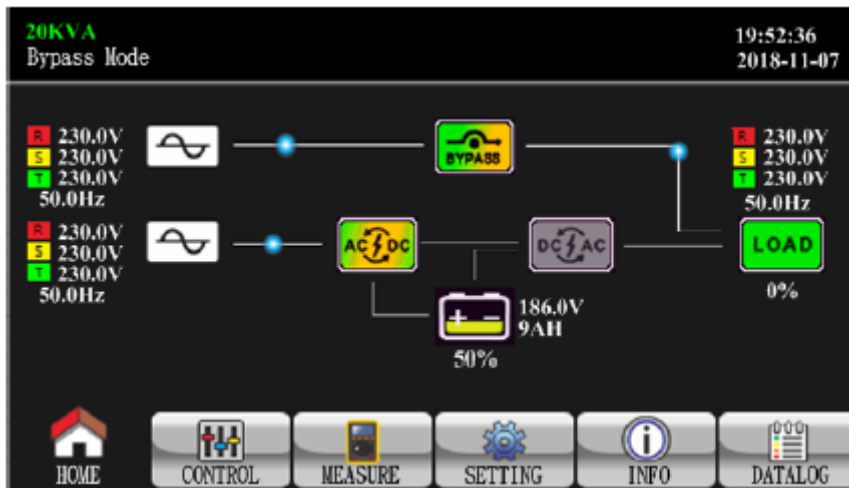

The main menu of the display shows the current operating mode of the UPS (energy flow through individual functional blocks) and the parameters of power supply, batteries and UPS outputs. To return to the main window from anywhere else, use the icon .

#### 4.2. UPS control window

Control menu  allows you to turn the UPS inverter on or off, run a battery test and silence the audible alarm.

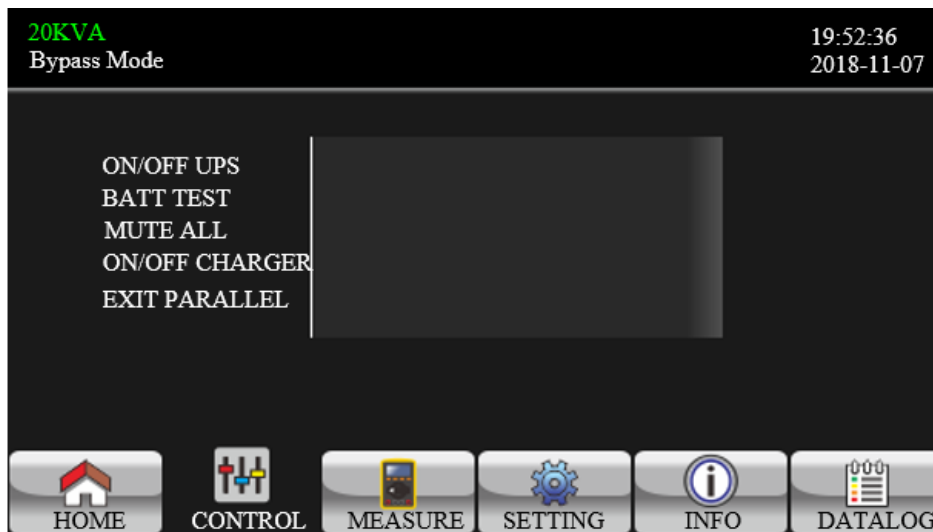

Select the UPS ON / OFF command to enable or disable the UPS inverter. The display will switch to the following view asking you to confirm or cancel your selection.

Click "YES" to turn on / off the UPS. The display will return to the main window view. Click "BACK" or "No" to return to the control window.

The display in the main window will show messages related to turning the UPS on (Turning on) or turning off the UPS (Turning off).

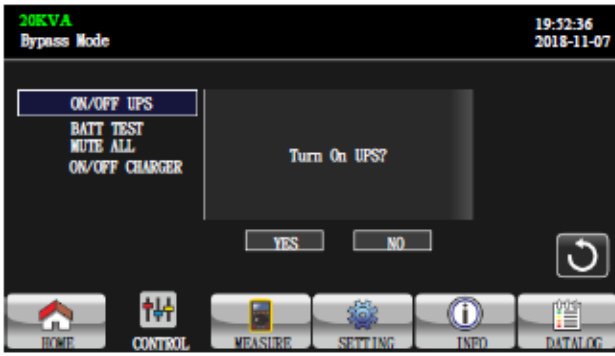

Turn on UPS

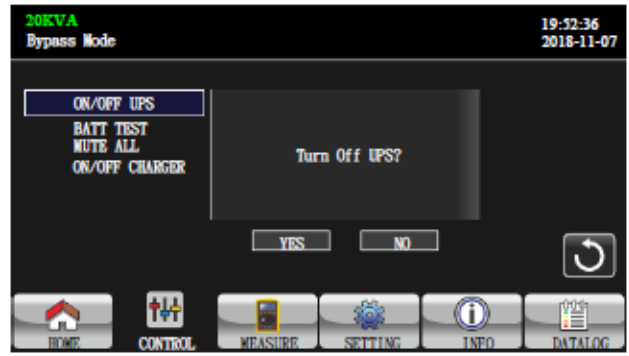

Turn off UPS

To start the battery test, select the "BATT TEST" command and confirm your selection with the "YES" key.

To cancel the test, select the return to the "Back" menu or the "No" command.

The display in the main window will show messages related to Battery testing or Battery test failed.



Turn on battery test

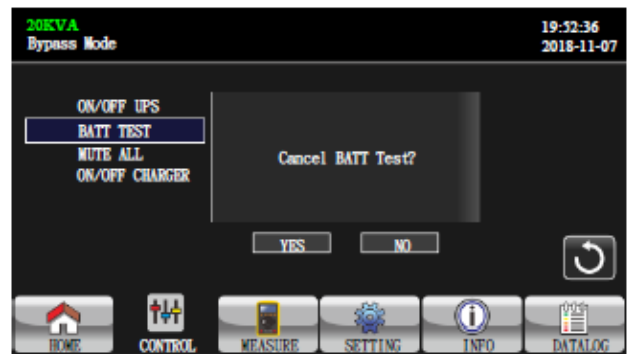

Turn off battery test

To silence the audible alarm, select the "MUTE ALL" command and confirm your selection with the "YES" key.

To turn mute off, choose "Back" or with the command "No".

The mute icon appears on the display in the main window in the upper left corner .

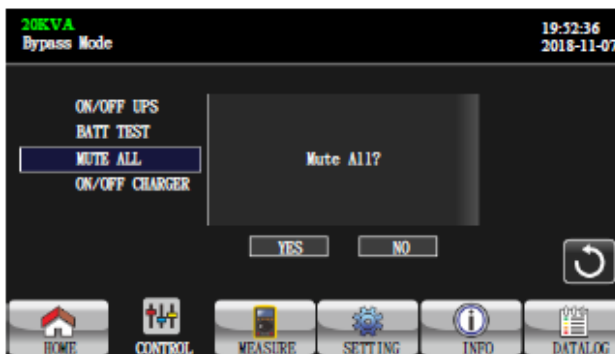

Mute alarm

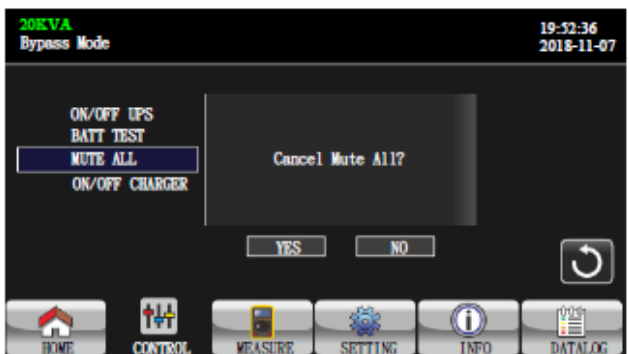

Cancel mute alarm

The control menu also allows you to switch the battery charger on or off. Selecting the "ON / OFF CHARGER" command enables it to turn on "Turn on Charger" if it is not working, or to turn it "Turn off Charger" if it is currently active.

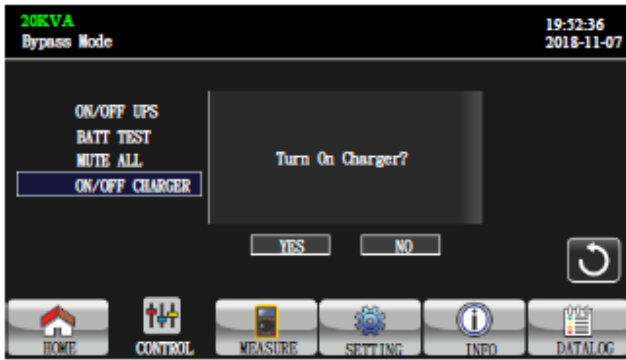

Turn on charger

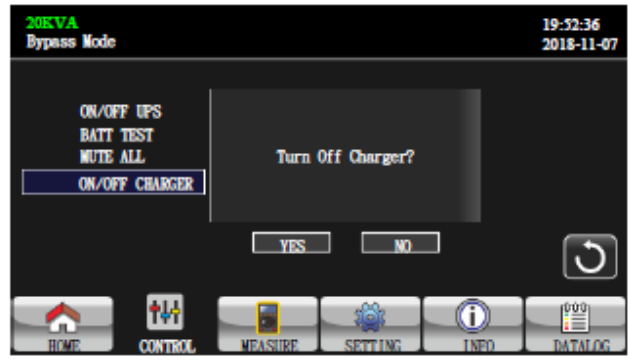

Turn off charger

### 4.3. Measure window

The screens below show a 3: 3 configuration. For a 3: 1 configuration, only 1 Output Phase and Bypass are displayed.



In the measurements tab there are three windows between which you can switch with the arrow keys up / down. The first window contains information about the parameters:

- Phase voltage of the L-N rectifier supply
- Phase-to-phase voltage of the L-L rectifier supply
- Rectifier supply frequency
- L-N inverter phase voltage
- L-L inverter phase-to-phase voltage
- Inverter frequency
- L-N phase voltage of the bypass supply
- Phase-to-phase voltage of the L-L bypass
- Bypass supply frequency
- Phase voltage at the UPS L-N output
- Phase-to-phase voltage at the UPS L-L output
- UPS output frequency



The following measurements are available in the second measurement window:

- Apparent power on the UPS
- Active power on the UPS
- Percentage of active power load of each output phase
- Percentage of apparent power load of each output phase
- Total percentage of active power load on the UPS
- Total UPS apparent power percentage
- Battery voltage +/-
- DC BUS +/- voltage
- Battery charging current
- Battery discharge current
- R / S / T temperatures

20KVA Bypass Mode 19:52:36 2018-11-07

OUTPUT W		OUTPUT VA		BATT P VOL		204.0V	
R:	4W		46VA	BATT N VOL		204.0V	
S:	5W		46VA	BUS P VOL		370.3V	
T:	1W		46VA	BUS N VOL		370.5V	
OUTPUT W(%)		OUTPUT VA(%)		CHARG CURR		3.9A	
R:	0%		0%	DISCHG CURR		0.0A	
S:	0%		0%				
T:	0%		0%				
TOTAL W(%)		TOTAL VA(%)					
	0%		0%				

TEMP - C		TEMP R		27	
		TEMP S		27	
		TEMP T		27	

Navigation: HOME, CONTROL, MEASURE, SETTING, INFO, DATALOG. Page: 2/3

The third tab offers measurements of input and output currents, power factors, and measurements of active and apparent input power as well as the load percentage.

20KVA Bypass Mode 19:52:36 2018-11-07

INPUT W		INPUT VA		INPUT CURR		INPUT PF	
R:	4W		46VA	R: 0.3A		0.08	
S:	4W		46VA	S: 0.3A		0.08	
T:	4W		46VA	T: 0.3A		0.08	
INPUT W(%)		INPUT VA(%)		OUTPUT CURR		OUTPUT PF	
R:	0%		0%	R: 0.3A		0.08	
S:	0%		0%	S: 0.3A		0.08	
T:	0%		0%	T: 0.3A		0.08	
TOTAL W(%)		TOTAL VA(%)					
	0%		0%				

Navigation: HOME, CONTROL, MEASURE, SETTING, INFO, DATALOG. Page: 3/3

#### 4.4. UPS configuration window (Setting)



In the configuration tab **SETTING** there are two setting levels to choose from. Basic mode (GENERAL) for the user allows setting

- Time
- Dates
- Language selection
- Power sources network / generator
- Service telephone number
- Contact person
- Service email address
- Mute alarms



Password authorization is required in the advanced mode available for the service.

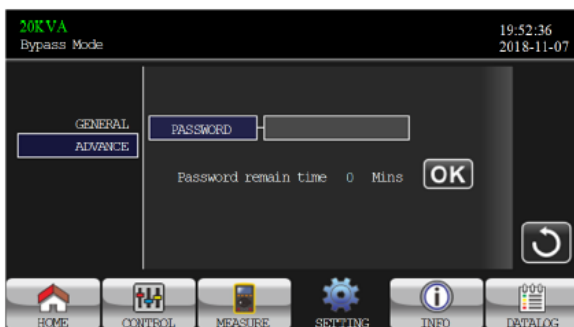

Enter the password



Password incorrect

In the service mode, it is possible to configure the electrical parameters:

- Voltage, frequency
- Working mode
- Voltage tolerance ranges etc.



Battery parameters:

- Warning levels for high and low battery voltage
- Cut-off voltage
- Capacity and number of battery chains etc.



Other detailed settings are available exclusions for service technicians.

Other UPS parameters:

- Possibility to set the UPS to restart after the battery is discharged
- UPS shutdown delay
- UPS switch-on delay after power recovery
- Password change

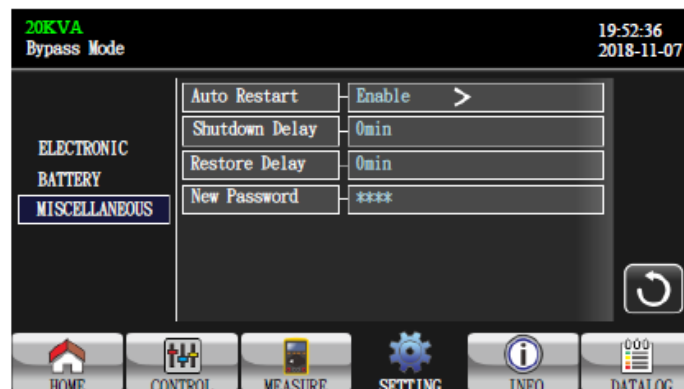

#### 4.5. Information window



In the information tab there is access to all configured parameters of the UPS, information about the software version, serial number, etc. In the user mode, it is only possible to view the parameters without the possibility of changing them.



#### 4.6. Alarm window



In the alarms tab current existing alarms and warnings are shown. Sample battery disconnected alarm below:



## 5. Audible alarms and event codes

### 5.1. Audible alarms

Description	Alarm	The possibility of mute
Bypass mode	1x / 2 minutes	YES
Battery mode	1x / 4 seconds	
Damage	continuous	
Overload	2x / 1 second	NO
Other	1x / 1 second	YES

### 5.2. Warning codes

Code	Error	Code	Error
01	Batteries not connected	36	Unbalanced inverter current
02	N wire missing	3A	Service Bypass included
04	Incorrect phase sequence of the rectifier power supply	3C	Extremely unbalanced load
05	Incorrect phase sequence of the bypass supply	3D	Unstable bypass
07	Battery overcharging	3E	Battery voltage too high
08	Low battery voltage	3F	Battery voltage unbalanced
09	Overload	40	Charger short circuit
0A	Fan failure	41	No Bypass power
0B	Active EPO	42	Isolation transformer overheating
0D	Overheating	43	DC BUS Soft Start Error
0E	Charger failure	44	EEPROM reset
21	Different rectifier feed lines in a parallel system	45	External output switch open
22	Various bypass feed lines in a parallel system	46	External battery switch open
33	Bypass mode lock after 3 times overload for 30 minutes	47	External Bypass switch closed
34	Inverter is out of symmetry	48	External input signal open



## 6. UPS operations

### 6.1. Turn on the UPS from the mains

1. Turn on the output disconnect switch on the rear panel of the UPS..
2. Turn on the battery disconnecter located near the battery cabinet in the case of external batteries to the ON position.
3. Turn on the bypass and UPS rectifier disconnectors. When power is applied, the LCD panel lights up and the fans start to run. A few seconds later, the UPS enters Bypass mode.

---

*Turning on the UPS power will turn on the Bypass mode. At this time, the receivers are supplied with voltage from the UPS input and are not protected against power outages. To start the UPS inverter, turn on the UPS - control menu.*

---

4. In order to turn on the power supply, select the Control tab and the Turn on command.
5. A few seconds later, the UPS turns on the inverter and starts normal operation.

---

*If the supply voltage is out of tolerance, the UPS starts to work from the battery. When the battery is discharged, the power is turned off. The restoration of the power supply automatically restarts the UPS to normal operation.*

---

Attention! In order to obtain the maximum autonomy, charge the batteries at least 10 hours after the first start. The maximum capacity of the battery is obtained after two complete discharge / charge cycles.

### 6.2. UPS shutdown

1. Turn off the UPS inverter by selecting "OFF UPS" in the control window. The UPS will transfer to Bypass mode.

---

*In the event that the UPS is operating on battery, the above procedure turns off the UPS and the voltage at the UPS output.*

---

2. In Bypass mode, the output voltage is supplied directly from the mains. To completely shut down the UPS, turn off the loads connected to the UPS and then disconnect the UPS power. Seconds later, the UPS turns off the LCD panel and stops the fans.
3. Turn the battery circuit breaker to the OFF position.
4. Turn the output disconnect switch to the OFF position.

### 6.3. Turn on the UPS from the battery

1. Turn on the output disconnect switch on the rear panel of the UPS.
2. Turn on the battery disconnecter located near the battery cabinet in the case of external batteries to the ON position.
3. Press the "Power ON" button to turn the UPS into Stand-by mode. After the display is on, select the "On" command in the control menu to turn on the inverter and apply voltage to the UPS output.
4. A few seconds later, the UPS enters Battery mode.

## 6.4. Switching UPS to the Maintenance Bypass mode

---

*The following procedure is for a UPS equipped with an external Maintenance Bypass. Switching the UPS to the Maintenance Bypass mode means that the receivers are not protected against power outages.*

---

1. Turn off the UPS inverter (control tab). UPS will confirm shutdown with a single beep and switch to Bypass mode.
2. Switch the external Maintenance Bypass from UPS position to BYPASS position.
3. To completely shut down the UPS, turn off the UPS power. Seconds later, the UPS turns off the LCD panel and stops the fans.
4. Turn the battery circuit breaker to the OFF position.

## 6.5. Switching the UPS from Maintenance Bypass mode

1. Turn on the output disconnect switch on the rear panel of the UPS.
  2. Turn on the battery disconnecter located near the battery cabinet in the case of external batteries to the ON position.
  3. Switch on the UPS power in the UPS distribution board. When power is applied, the LCD panel lights up and the fans start to run. A few seconds later, the UPS enters Bypass mode.
- 

*Make sure the Bypass LED is on to go to the next step.*

---

4. Switch the external Maintenance Bypass from BYPASS position to UPS position.
5. In order to turn on the power supply (start the inverter), select the "Turn on" command in the control tab.
6. A few seconds later, the UPS turns on the inverter and starts normal operation.

## 6.6. Installing the software

To take full advantage of the UPS, please install the provided ViewPower communication software. During the installation, follow the instructions on the computer screen. You must restart your computer after the installation process is complete. Restarting the computer will automatically launch ViewPower, as shown by the ViewPower icon in the Windows system tray.

Środowisko pracy i eksploatacja UPS

## 6.7. Working conditions

To ensure the proper working conditions for the uninterruptible power supply system, the room with the power supply must be clean, free of dust and dirt. From time to time (at least every 6 months or more often depending on the degree of soiling), clean the ventilation holes on the power supply to ensure free air flow. To extend battery life, the ambient temperature should be between 15-25 ° C.

## 6.8. The storage conditions

If the UPS is not in use and storage or storage is envisaged, the batteries must be recharged periodically to avoid damaging them. Depending on the storage temperature, the power supply should be connected at least every 6 months to charge the battery. Typically, the batteries are charged within 4 hours to 90% of their capacity, while it is recommended to leave the power supply on for a period of 24-48 hours to fully charge the batteries, which will extend their life.

---

*Temp. storage up to 20 ° C - charging every 6 months.*

*Temp. storage up to 30 ° C - charging every 3 months.*

*Temp. storage up to 40 ° C - charging every 1 month*

---

## 6.9. Battery change

If the operating time of the UPS is halved with the batteries working properly, or the UPS reports a battery alarm, the batteries should be replaced immediately.

---

*After disconnecting the batteries, the receivers are not protected against power outages.*

---

---

*It is not recommended to replace the batteries while the UPS and receivers are operating.*

---

---

*It is not allowed to replace the batteries while the UPS is operating in battery mode!*

---